

ACOM



ACOM 1200S

1.8-54 MHz
Linear Power Amplifier

User's Manual

Installation, Operation
and Maintenance

OUTSTANDING HF POWER PRODUCTS

August 2021

This manual is for electronic distribution mainly.
If you have it on paper and you no longer need it, please, recycle it!

The latest versions of our User's Manuals are available at
www.acom-bg.com

ABOUT DOCUMENTATION

All ACOM documentation (including manuals, brochures, specifications, descriptions, presentations, video materials, etc.) are based on the latest available information at the time of creation of our documents.

As we always strive to constantly improve and update our products, ALL PRODUCTS, PRODUCT SPECIFICATIONS AND DATA ARE SUBJECT TO CHANGE. ACOM reserves the right to make changes and improvements at any time without further notice or obligation to notify any person or organization of such revisions or changes, made in order to improve the reliability, function, quality and design, and/or performance of the ACOM products and services.

Further, this User's Manual is provided AS IS and ACOM shall not be liable for possible errors contained herein.

This manual supersedes all previous editions, which thereby become invalid.
The cover images used in the manual are illustrative only.

We are continuously striving to improve our documentation, but nobody is perfect.
And our documentation is not an exception of this rule.
Have you found any errors or would you like to suggest changes in our documentation?
Please help us by sending your suggestions to the following e-mail address:
documentation@acom-bg.com

The latest versions of our User's Manuals are available at
www.acom-bg.com

We highly recommend you to use this manual in electronic form as PDF-file instead of printed version. The PDF-file is easy to read on any computer, tablet, smart phone or other similar device. In the PDF file you will find the necessary information very fast due to context-oriented links (marked in **orange**) inside the file, including context-linked Table of Content.

To open PDF-files you can use any free PDF viewer, for example:

- Adobe Acrobat Reader DC (<https://get.adobe.com/reader>);
- Foxit Reader (<https://www.foxitsoftware.com/pdf-reader>);
- Your web browser. Web browsers like Google Chrome, Firefox and Safari all have integrated PDF readers.

- Title of Documentation** ACOM 1200S 1.8-54 MHz Linear Power Amplifier
User's Manual
Installation, Operation and Maintenance
- Type of Documentation** User's Manual
- Purpose of Documentation** This manual explains Installation, Operation and Maintenance of the ACOM 1200S 1.8-54 MHz Linear Power Amplifier.

Record of Revisions	Description	Release Date	Notes
	ACOM 1200S User's Manual	-	First edition
	ACOM 1200S User's Manual	-	Second edition
	ACOM 1200S User's Manual	11.05.2017	Third edition
	ACOM 1200S User's Manual	30.08.2021	Fourth edition, R01

Validity The specified data is for product description purposes only and may not be deemed to be guaranteed unless expressly confirmed in the contract. All rights are reserved with respect to the content of this manual and the availability of the product.

Copyrights © 2021 ACOM Ltd.
Copying this document, giving it to others and the use or communication of the contents thereof without express authority, are forbidden. Offenders will be held liable for infringement of any intellectual property of ACOM Ltd. and all damages which may rise as a result.

Published by ACOM Ltd.
Bulgaria | Bozhurishte 2227
Sofia-Bozhurishte Economic Zone | 6 Valeri Petrov Str.
GPS coordinates: 42.748616° | 23.209801°
Web: www.acom-bg.com
E-mail: documentation@acom-bg.com

Note This manual has been printed on chlorine-free bleached paper.

Contents

ABOUT DOCUMENTATION	3
1. GENERAL INFORMATION	8
1.1. Introduction and Description	8
1.2. Owner Assistance	9
1.3. Equipment Supplied	9
1.4. Features.....	10
1.5. Safety Considerations, Explicit Definitions.....	11
2. INSTALLATION.....	14
2.1. Unpacking and Initial Inspection	14
2.2. Line Voltage Selection	14
2.3. Amplifier Location Selection	15
2.4. Connections.....	16
2.5. Connecting to External Devices (transceiver, computer, etc.) and User Settings	20
3. FIRST POWER-ON, CONTROL SYSTEM, AND INITIAL CHECK.....	22
3.1. Low Energy STANDBY Mode of the Power Supply	22
3.2. Front Panel	23
3.3. Initial Turning On.....	23
3.4. Basic Screen.....	24
3.5. Control System - Buttons and Menus	25
3.6. Test Transmission.....	26
4. OPERATION.....	30
4.1. Change of Modes RX/TX and OPERATE/STANDBY; AUTO OPERATE User Setting	30
4.2. Band Change, Standard and Expanded Frequency Coverage	31
4.3. Operation with an External Antenna Tuner	32
4.4. Automatic Protection System	33
5. MENUS - SETTINGS AND OPTIONS	36
5.1. Menu AMP MEASURE (Amplifier Measurements).....	37
5.2. Menu AMP SERVICE (Amplifier Service Functions)	38
5.3. Menu CAT/AUX SETTINGS (Selection of CAT/AUX Interface)	39
5.4. Menu USER PREFERENCES	41

- 5.5. Menu FAULTS LOG 42
- 5.6. Menu RESTORE DEFAULT SETTINGS..... 43
- 6. REMOTE CONTROL 44
 - 6.1. Remote Control via ACOM eBox 44
 - 6.2. Remote Control via RS-232 interface 44
- 7. MAINTENANCE 45
 - 7.1. Periodic Maintenance 45
 - 7.2. Cleaning..... 47
 - 7.3. Fuse Replacement 47
 - 7.4. Using the Fault Codes (signatures) for Diagnostics..... 49
 - 7.5. Firmware 50
 - 7.5.1. Firmware Versions 50
 - 7.5.2. Prequistments..... 50
 - 7.5.3. Firmware Updates 50
- 8. SPECIFICATIONS..... 52
 - 8.1. Parameters 52
 - 8.2. Functions 54
 - 8.3. Storage and Shipment..... 55
 - 8.3.1. Storage Environment..... 55
 - 8.3.2. Shipping Size and Weight 55
 - 8.3.3. Transportation 55
 - 8.3.4. Returning to the Service Provider 55
 - 8.4. Information on Disposing and Recycling of Old Electrical and Electronic Equipment 56
- NOTES 57

Figures

- Figure 2-1 Front panel - Ergonomic position with tilt foot bar 15
- Figure 2-2 Rear panel - Connections 16
- Figure 3-1 Front panel - Controls and Readouts 22
- Figure 3-2 Basic screen without ACOM 04AT antenna tuner assigned..... 24
- Figure 4-1 ACOM 04AT Remote Automatic Antenna Tuner and Switch 32

Figure 4-2 Amplifier screen with ACOM 04AT antenna tuner installed 33

Figure 4-3 Appearance of an alarm message 34

Figure 5-1 MENU SELECTION 36

Figure 5-2 Menu AMP MEASURE..... 37

Figure 5-3 Menu AMP SERVICE 38

Figure 5-4 Menu CAT/AUX SETTINGS 39

Figure 5-5 Menu USER PREFERENCES 41

Figure 5-6 Menu FAULTS LOG 42

Figure 5-7 Menu RESTORE DEFAULT SETTINGS..... 43

Figure 6-1 ACOM eBox Ethernet Remote Control device 44

Figure 7-1 Bottom view - Air Filters..... 46

Figure 7-2 ACOM Terminal S screenshot..... 51

Figure 8-1 Packaging cardboard box 55

Tables

Table 2-1 Signals and pin out of the CAT/AUX connector 20

Table 2-2 Signals and pin out of the RS-232 connector 21

Table 5-1 Transceiver interface type and command set selection..... 40

Table 7-1 ACOM 1200S firmware versions history..... 50

1. GENERAL INFORMATION

Congratulations on purchasing one of the finest HF amplifiers in the world today.

ACOM is pleased that you have chosen one of our products, and we will endeavor to provide you with the information and support you need to enjoy your purchase for many years.

We urge you to read all of the following materials before you embark on operating your new amplifier.

1.1. Introduction and Description

This manual explains:

- Installation
- Operation and
- Maintenance

of the ACOM 1200S HF + 6 m solid-state linear power amplifier.

The ACOM 1200S is a state-of-the art linear power amplifier that covers all amateur bands from 1.8 through 54 MHz and provides 1000 W output power (PEP or continuous carrier) with less than 50 W of drive. The amplifier operating information is shown on a multi-functional, high resolution color display. ACOM 1200S can be controlled either by the six front-panel buttons or remotely.



The ACOM 04AT Remote Automatic Antenna Tuner and Switch is designed to work with our transistor (solid state) amplifier series, including the ACOM 1200S (see Section [4.3 Operation with an External Antenna Tuner](#)).



Remote control of ACOM 1200S is provided by ACOM eBox Ethernet Remote control device or RS-232 port (see Section [6 REMOTE CONTROL](#)).

1.2. Owner Assistance

If assistance is needed, you should contact your local dealer first. If necessary, your dealer will contact ACOM for additional guidance.

If you still have an issue you need to discuss with one of ACOM's specialists, the contact information is as follows:

ACOM Ltd.

E-mail: support@acom-bg.com

Bulgaria | Bozhurishte 2227

Sofia-Bozhurishte Economic Zone | 6 Valeri Petrov Str.

GPS coordinates: 42.748616° | 23.209801°

1.3. Equipment Supplied

The ACOM 1200S amplifier and this User's Manual are shipped in a cardboard box.

1.4. Features

- **Easy to operate**
The overall operation of ACOM 1200S is extremely simplified: the screen menus are intuitive and easy to follow, no special skill is required from the operator when changing frequency bands.
- **User-friendly automatic control**
When connected to a transceiver with CAT capability, the amplifier will track the operating frequency, and will change bands accordingly.
Even if not CAT connected, the amplifier monitors the input signal frequency through the built-in frequency counter and automatically switches bands.
- **High resolution color display**
All amplifier status indications are explained via detailed text displayed on the 5" high resolution color display (108x65 mm, 800x480 pixels, and 24-bit color).
- **Transceiver-independent**
Compatible with all transceiver models - does not need any special signals: "ground on transmit" and less than 50 W of RF drive power is sufficient.
- **LDMOS transistor technology**
The final PA stage uses a rugged LDMOS transistor - BLF188XR or equivalent.
- **Broadband input circuit**
Broadband input circuit, providing a perfect transceiver load with SWR below 1.2 (typically 1.1), without retuning throughout the whole frequency range from 1.8 to 54 MHz.
- **Intelligence**
Takes care of itself during operation via continuously working protection circuits in all modes.
The operator can monitor more than 10 parameters of the amplifier in operation.
- **Easy maintenance**
Detailed data (55 parameters) about each of the last 28 hard-fault protection trips is stored in the amplifier's memory.
- **Remote control capabilities**
Remotely controlled by RS-232 port and via Internet by the ACOM eBox Ethernet Remote Control device.
- **Compact and lightweight construction**
Convenient for expeditions and field operation due to the extremely compact and lightweight construction and the built-in switching-mode power supply (SMPS) that operates with extended mains voltage range of 100-240 VAC (output power reduced to about 500 W PEP below 200 VAC), with no internal switch over. The consumed current is purely sinusoidal, Power Factor Corrected (PFC) and inrush limited. This makes the operation from unstable mains and generators easy and trouble free.
- **Electromagnetic compatibility**
Perfect electromagnetic compatibility (EMC) with both highly sensitive devices and the powerful devices in the radio station (receivers, computers, other amplifiers) exceeding the standard EMC requirements due to the used PFC and built-in radio-frequency filters.

1.5. Safety Considerations, Explicit Definitions

The ACOM 1200S linear power amplifier is a Safety Class I unit regarding protection against electric shock. The third grounding lead of its mains cord (which is colored yellow with two green stripes) and the ground stud on the rear panel of the amplifier (marked **GND**, see [Figure 2-2 Rear panel - Connections](#), Pos. (a)) must be connected to the station's grounding system for safe operation.

The amplifier is designed to meet international safety standards and complies with the CE safety and electromagnetic compatibility requirements, as well as the FCC regulations.

This User's Manual contains information, warnings (signal words **Danger**, **Warning**, **Caution** and **Notice**) and instructions, related to hazards, that should be followed by the user in order to ensure safe operation and to keep the amplifier in a safe working condition at all times.

The EXPLICIT DEFINITIONS described below apply to this User's Manual:

DANGER

*These notes call attention to a procedure or instructions which, if not correctly performed, **will result in serious personal injuries and even death.***

WARNING

*These notes call attention to a procedure or instructions which, if not correctly performed, **could result in serious personal injuries and even death.***

CAUTION

*These notes call attention to a procedure or instructions which, if not correctly performed, **could result in minor or moderate personal injuries.***

NOTICE

*These notes call attention to a procedure or instructions which, if not correctly performed, **could result in property damage or equipment damage not exclusively to the amplifier but also to connected equipment.***

Information notes described below apply to this User's Manual:



These notes highlight operating procedures or practices that may improve equipment reliability and/or personnel performance, or to emphasize a concept.

ORANGE TEXT as LINKS

marks all internal links in the document between Sections, Figures, Tables, etc. for your convenience.



The safety instructions contained in this User's Manual feature specific signal words (**Danger**, **Warning**, **Caution** or **Notice**) and, where required, a safety alert symbol, in accordance with actual standards ISO 3864 or ANSI Z535.

PRECAUTIONS:

DANGER

Both the mains voltage and the high DC voltage up to 500 V inside the ACOM 1200S amplifier are LETHAL!

For your safety, pull the amplifier power plug out of the mains wall outlet and WAIT AT LEAST 3 minutes EACH TIME BEFORE you remove the cover of the amplifier.

DANGER

Never allow anyone, ESPECIALLY CHILDREN, to push or put anything into holes in the case - this will cause electric shock. NEVER TOUCH AN ANTENNA or antenna insulators during transmission or tuning - this may result in an electric shock or burn. NEVER EXPOSE the amplifier to rain, snow or any liquids. AVOID placing the amplifier in excessively dusty environments or in direct sunlight. DO NOT OBSTRUCT COOLING ducts or vents. Keep a minimum clearance distance of 10 cm (4 inches) to any other devices or objects.

WARNING

Do not undertake on your own repairs or changes in hardware or software of the amplifier in order not to endanger your or other's health and life and not to damage the amplifier and the equipment connected with it, not covered by warranty. The manufacturer is not liable for another's actions and responsibility shall be assumed by the doer.

WARNING

To avoid damage (not covered under warranty) read the Section **2 INSTALLATION** of this User's Manual carefully. If you have any doubts about the installation, operation or safety of the amplifier, please, consult your dealer.

2. INSTALLATION

2.1. Unpacking and Initial Inspection



Before you install your amplifier, thoroughly read this manual.

First, carefully inspect the cardboard carton and its contents for physical damage. ACOM ships amplifiers in highly protected containers, but it cannot assure that mistreatment by shippers will not occur. If damage is evident, notify your dealer immediately. Delay may void the carrier's warranty.

Keep all packing materials for possible future amplifier shipment (see Section [8.3.4 Returning to the Service Provider](#)).

2.2. Line Voltage Selection

The ACOM 1200S amplifier is supplied with built-in switching-mode power supply (SMPS).

The amplifier operates in an extended mains voltage range of 100-240 VAC (output power reduced to about 500 W PEP below 200 VAC), with no internal switch over. The consumed current is purely sinusoidal, Power Factor Corrected (PFC) and inrush limited. This makes the operation from unstable mains and generators easy and trouble free.



Thanks to the built-in SMPS, the ACOM 1200S has no mains line voltage selector to take care of!

2.3. Amplifier Location Selection

CAUTION

The weight of the unit is about 16 kg, which should preferably be handled by two persons.

Position the amplifier near the place where it will be used. You will need an easy access to the command buttons on the front panel, as well as to the rear panel cabling.

NOTICE

The ACOM 1200S is forced air cooled. Keep a minimum clearance distance of 10 cm (4 inches) to any other devices or objects.

The exhaust air can reach 65 °C (150 °F) and if the surrounding devices are sensitive to heating from outside or use forced air cooling themselves, increase the distances accordingly.



Figure 2-1 Front panel - Ergonomic position with tilt foot bar

NOTICE

Do not leave accidental paper, cloth or other lightweight pieces around and under the amplifier. They may be drawn in by the cooling air stream and block the vents. This will lead to overheating and accelerated material aging, not covered by the warranty.

2.4. Connections

Please, see **Figure 2-2 Rear panel - Connections**.

Connection to your station must be accomplished in the order described below, before you apply mains voltage to the amplifier.



Before you connect the amplifier to external grounding, you should advise with a licensed electrician and confirm such kind of connection is allowed by your national and local electrical code, safety rules, and regulations in force. Simultaneous connection to the earth grounding and protective earth may be inadmissible or may fall under special requirements in some countries!

⚠ DANGER

Never use the gas installation pipes for grounding. This can cause an EXPLOSION!

⚠ DANGER

Do not use the steam-heating or water-supply network pipes for grounding! You may expose to dangerous voltage not only yourself but also other people using the same installation.



Figure 2-2 Rear panel - Connections

a) **GND** stud

First, connect the wing-nut grounding stud of the amplifier (on the rear panel, marked **GND**) to the station's grounding system (see [Figure 2-2 Rear panel - Connections](#), Pos. (a)).

⚠ WARNING

Note that the grounding system may have to withstand currents over 15 A with insignificant voltage drop on it. Therefore, it may be necessary to improve it considerably, i.e., to become less resistive, with heavier leads and lower-resistive ground path. The grounding leads should be at least 4 mm² (AWG 11 or SWG 13).

For details and recommendations on the grounding and RF counterpoise system concerning the electromagnetic compatibility see also Section [3.6.f\) Elimination of electromagnetic compatibility \(EMC\) problems](#).

b) **KEY-IN** socket

This is the amplifier's input for receive/transmit control from the transceiver.

The transceiver controls the amplifier from receive mode into transmit mode (RX/TX) by grounding of the **KEY-IN** input.

Run a shielded cable from the "ground on transmit" socket or terminal on your transceiver to the amplifier rear panel **KEY-IN** socket (see [Figure 2-2 Rear panel - Connections](#), Pos. (b)). The **KEY-IN** socket uses a standard RCA phono plug.



The switching voltage presented from amplifier **KEY-IN** socket to the transceiver "ground on transmit" output does not exceed 12 V (positive to the ground). The closed-circuit current is below 6 mA (see Section [8.1.j\) Receive / transmit control](#)).



Your amplifier will not work if **KEY-IN** input is not connected properly. Transceiver producers give different names to this output and they are for instance TX-GND, SEND, T/R-LINE, PTT, etc. Some transceivers require that "ground on transmit" is implemented via a software command, or by changing the setting of a switch on the rear panel, or interior of the transceiver. Check your transceiver's manual.

c) **KEY-OUT** socket

This is the amplifier's transmit-enabling control output to the transceiver.

The **KEY-OUT** socket on the rear panel provides an extra control signal from the amplifier to the transceiver. This can be used for improving the receive/transmit (RX/TX) switching safety.

NOTICE

KEY-OUT is a low-power open-drain output, make sure that the signal voltage coming from the respective transceiver connection does not exceed 50 VDC (open circuit) and the closed-circuit current is below 20 mA.

If your transceiver has a suitable input that disables transmission unless grounded externally, we recommend that you connect it with a shielded cable terminated in a Phono (RCA) connector to the **KEY-OUT** socket (see *Figure 2-2 Rear panel - Connections*, Pos. (c)) of the amplifier.



ACOM 1200S will operate normally with **KEY-OUT** unconnected if your transceiver has no such input.

Transceiver producers give different names to this input and they are for instance TX-INHIBIT, MUTE, LINEAR, etc. Check your transceiver's manual.

d) **RF INPUT** socket

Connect a suitable coaxial cable from the transceiver output to the amplifier **RF INPUT** SO-239 socket (see *Figure 2-2 Rear panel - Connections*, Pos. (d)), using PL-259 plug.

NOTICE

In order to avoid a damage, turn off your transceiver's internal antenna tuner.

e) **RF OUTPUT** socket

NOTICE

If this is the first time you will use a power amplifier in your station, pay attention to the coaxial cable type from the amplifier's output to the antenna. It must handle the increased power safely, particularly on the 10- and 6 meters bands. We recommend that you use RG213 cable or better. Check the same for the antenna switch and tuner, as well as the whole antenna system (especially multi-band trap antennas).

Connect a suitable coaxial cable with a PL-259 plug from the **RF OUTPUT** (see *Figure 2-2 Rear panel - Connections*, Pos. (e)) to the antenna switch or tuner, or to antenna for the respective frequency band.

f) Main fuses

Please, see **Figure 2-2 Rear panel - Connections**, Pos. (f).

NOTICE

If occasion should require replacement of the mains fuses, replace them as described in Section **7.3 Fuse Replacement!**

g) The IEC 320 Power inlet

Please, see **Figure 2-2 Rear panel - Connections**, Pos. (g).

Due to the different standards in different countries, the power supply cable and mains plug are supplied and mounted by the dealer. He connects to the mains cord end a standard mains supply plug which meets the Safety Class I unit standard in your country.

h) Preparation of wall outlet

⚠ WARNING

Before connecting the amplifier to your mains supply using a licensed electrician, check that the supply is correctly wired, and is adequate for the current drawn by the amplifier (up to 10 A). Make certain that the grounding lead is connected properly and that it has a cross section not less than the cross section of the phase conductor in the wall outlet for the amplifier.

It is preferable that you use the wall outlet closest to the source. The installation leads should be at least 1.5 mm² (AWG 15 or SWG 17) at operating 200-240 VAC or 100-120 VAC (recommended values if there are no stricter requirements by your local standard).

Check that the panel fuse has a free capacity for the additional load from the amplifier as specified in Section Specifications **8.1.h) Mains Power Consumption at Full Output Power**. If you connect the amplifier to a different mains outlet, be sure that you check it, too.

Make sure the main rocker Power Switch (see **Figure 2-2 Rear panel - Connections**, Pos. (3)), on the rear panel is in OFF position and insert amplifier's mains plug into the wall outlet prepared for it. The amplifier remains switched off.

2.5. Connecting to External Devices (transceiver, computer, etc.) and User Settings

a) **CAT/AUX interface connector**

Please, see **Figure 2-2 Rear panel - Connections**, Pos. (1).

CAT/AUX interface is used for connecting and operating with various transceiver models (see **Table 2-1 Signals and pin out of the CAT/AUX connector** below and the respective menu in Section **5.3 Menu CAT/AUX SETTINGS (Selection of CAT/AUX Interface)**, **Table 5-1 Transceiver interface type and command set selection** and **Figure 5-4 Menu CAT/AUX SETTINGS**).

Most of the modern transceivers can be connected by CAT to the ACOM 1200S. This will allow the amplifier to track the transceiver frequency without any transmission and change the bands automatically when in OPERATE mode. The cable can be supplied optionally, ordered separately or home brewed according to **Table 2-1 Signals and pin out of the CAT/AUX connector** and the transceiver's manual.

The CAT connection requires a cable made especially for the ACOM 1200S and your transceiver. If you need cable wiring diagrams, please, contact your dealer (see Section **1.2 Owner Assistance**).



Note that some of the connections - to the transceiver's BCD band data outputs and Band Voltage outputs do not provide an exact frequency data, but only band data. Those connections cannot be used when ACOM 1200S works together with ACOM 04AT because the tuner needs to know the exact frequency, not only the band.

CAT/AUX interface	Pin Nr.	Pin name	Description	Specification
 <p>D-sub connector, 15-pin, 3-row, female (Rear panel view)</p>	1	RxD	Receive Data	TTL input
	2	RxD	Receive Data	RS-232 input
	3	TxD	Transmit Data	RS-232 output
	4	TxD	Transmit Data	TTL output
	5	GND	Ground	0 Volt
	6	BAND voltage	Analogue input	0 to +8 V
	7	Band data 0	Bit 0	TTL input
	8	Band data 1	Bit 1	TTL input
	9	Band data 2	Bit 2	TTL input
	10	Band data 3	Bit 3	TTL input
	11	ON RMT	Remote Pwr On	+4.5 to +15 V / 3 mA max
	12	Debug mode	CPU only Pwr input	+8 to +15 V / 0.4 A
	13	KEY-IN	Tx request	Less than +12 V / 6 mA
	14	KEY-OUT	Tx Ready	O.C. output, up to +50 V / 20 mA
	15	GND	Ground	0 Volt

Table 2-1 Signals and pin out of the CAT/AUX connector

b) **RS-232** interface connector

Please, see **Figure 2-2 Rear panel - Connections**, Pos. (2).

This connector may remain unused until you decide to control the amplifier remotely.

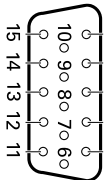
Please, see Section **6.1 Remote Control via ACOM eBox**.

RS-232 interface	Pin Nr.	Pin name	Description	Specification
 D-sub connector, 9-pin, female (Rear panel view)	1	-	Not connected	-
	2	TxD	Transmit Data	RS-232 level output
	3	RxD	Receive Data	RS-232 level input
	4	-	Not connected	-
	5	GND	Ground	0 Volt
	6	DSR	Remote Power On	RS-232 level input
	7	-	Not connected	-
	8	CTS	Remote Power On	RS-232 level input
	9	-	Not connected	-

Table 2-2 Signals and pin out of the RS-232 connector

3. FIRST POWER-ON, CONTROL SYSTEM, AND INITIAL CHECK

NOTICE

Do not turn the amplifier on for at least 2 hours after unpacking it in the room where it will be used. Pay particular attention when you move it from a very cold into a warm place - condensation is likely and this could result in damage to the high voltage circuits. In such a case, wait at least 4 hours. A similar effect can occur after a rapid warming of the operating room (for instance after switching on a powerful heater in a cold shack).

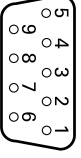
After following all instructions in Section **2 INSTALLATION**, check whether the rear panel mains rocker switch is turned OFF (see **Figure 2-2 Rear panel - Connections**, Pos. (3)). Then insert amplifier's mains plug into the wall outlet prepared for it. The amplifier remains switched off.



Figure 3-1 Front panel - Controls and Readouts

3.1. Low Energy STANDBY Mode of the Power Supply

Now you can turn on the mains rocker switch (see **Figure 2-2 Rear panel - Connections**, Pos. (3)). This will activate only the low-energy STANDBY mode of the amplifier power supply and the red LED above the front panel **POWER** button will light up (see **Figure 3-1 Front panel - Controls and Readouts**, Pos. (b)), while the main power supply is still off and the display is dark.

3.2. Front Panel

a) **POWER** button

Please, see [Figure 3-1 Front panel - Controls and Readouts](#), Pos. (a).

When the rear panel mains rocker switch is turned on, push and hold the **POWER** button for 1-2 seconds to start the amplifier up. In order to turn off the amplifier, push the **POWER** button to go back to low-energy STANDBY mode.

b) LED indicator above the **POWER** button

Please, see [Figure 3-1 Front panel - Controls and Readouts](#), Pos. (b).

When lit red and the screen is dark, the amplifier is in low-energy STANDBY mode and may be turned on by pushing the **POWER** button.

When you want to fully disconnect the mains power, switch off also the rear-panel rocker switch (see [Figure 2-2 Rear panel - Connections](#), Pos. (3)). The front-panel red LED should go off and the **POWER** button will become inoperative.

c) Functional buttons

Please, see [Figure 3-1 Front panel - Controls and Readouts](#), Pos. (c).

These six functional buttons are for manual (local) control of the amplifier. The function of each button is indicated on the display above it. Depending on the displayed menu, the buttons may have different functions (soft key).

d) A high resolution, 24-bit color display showing the operating information.

Please, see [Figure 3-1 Front panel - Controls and Readouts](#), Pos. (d).

3.3. Initial Turning On

In order to start up the amplifier, push and hold the front panel **POWER** button for one or two seconds. About ten seconds later (boot sequence) the display will flash and show the basic screen with the amplifier information (see [Figure 3-2 Basic screen without ACOM 04AT antenna tuner assigned](#)).

The amplifier may start in either STANDBY or OPERATE mode depending on AUTO OPERATE user settings (see Section [4.1.c\) AUTO OPERATE user settings](#)).

3.4. Basic Screen

The following information areas are to be distinguished on the basic screen:

- a) Information area for the frequency band

Please, see **Figure 3-2 Basic screen without ACOM 04AT antenna tuner assigned**, Pos. (a). The edges of the currently selected BAND are displayed. If the amplifier doesn't receive any operating frequency data from CAT or via RS-232, it will switch to the last used band.

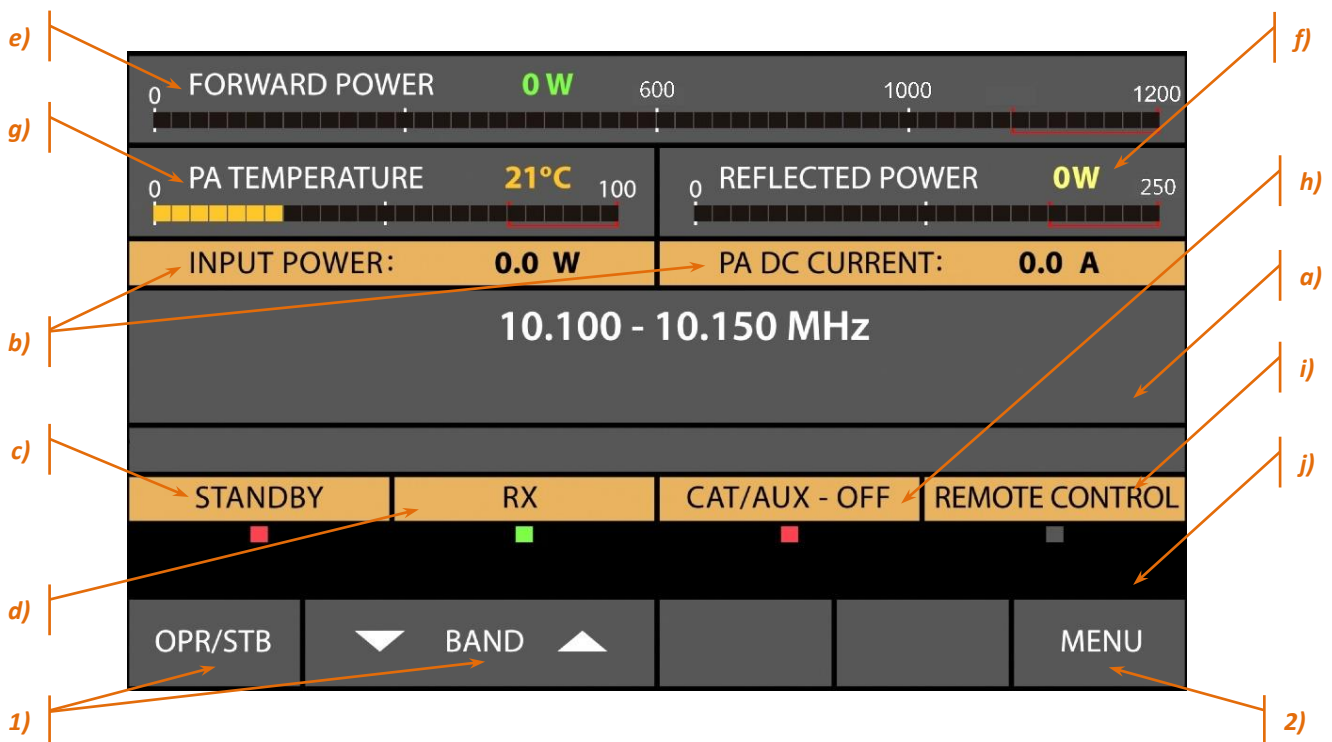

Figure 3-2 Basic screen without ACOM 04AT antenna tuner assigned

- b) Operating values

Please, see **Figure 3-2 Basic screen without ACOM 04AT antenna tuner assigned**, Pos. (b). Any two operating values selected in the AMP MEASURE menu will be shown here (see Section **5.1 Menu AMP MEASURE (Amplifier Measurements)**).

- c) Working mode indicator - OPR, STB or AUTO OPER

Please, see **Figure 3-2 Basic screen without ACOM 04AT antenna tuner assigned**, Pos. (c). For detailed information, please, refer to **4.1 Change of Modes RX/TX and OPERATE/STANDBY; AUTO OPERATE User Setting**.

d) RX/TX indicator

Please, see [Figure 3-2 Basic screen without ACOM 04AT antenna tuner assigned](#), Pos. (d).

RX/TX indicator reads the request for transmit (KEY-IN input). The RX indication is green and the TX is red. The indicator will flash frequently if switch over request is rejected by the amplifier controller.

e) Forward power bargraph and digital readout

Please, see [Figure 3-2 Basic screen without ACOM 04AT antenna tuner assigned](#), Pos. (e).

Displays the forward power fed into the antenna.

f) Reflected power bargraph and readout

Please, see [Figure 3-2 Basic screen without ACOM 04AT antenna tuner assigned](#), Pos. (f).

Entering the red zone is not allowed. Displays the power reflected from the antenna.

g) PA transistor temperature bargraph and readout

Please, see [Figure 3-2 Basic screen without ACOM 04AT antenna tuner assigned](#), Pos. (g).

Entering the red zone is not allowed.

h) CAT interface information

Please, see [Figure 3-2 Basic screen without ACOM 04AT antenna tuner assigned](#), Pos. (h).

When CAT is deactivated, this field is shaded.

i) REMOTE CONTROL information field

Please, see [Figure 3-2 Basic screen without ACOM 04AT antenna tuner assigned](#), Pos. (i).

Flashing the REMOTE CONTROL represents RS-232 port dataflow.

j) Alarm messages area

Please, see [Figure 3-2 Basic screen without ACOM 04AT antenna tuner assigned](#), Pos. (j).

Any alarm messages (either WARNING or SOFT FAULT) appear on yellow background and are flashing frequently in order to attract the operator's attention (see [Figure 4-3 Appearance of an alarm message](#)).

The WARNING messages appear only temporarily (for about three seconds), afterwards the indication is restored automatically (see Section [4.4.a First protection level - WARNING](#)).

The SOFT FAULT messages appear in the same field but they remain on the screen until the AUTO OPERATE time is elapsed (see Section [4.1.c AUTO OPERATE user settings](#)) or until the operator pushes any button.

3.5. Control System - Buttons and Menus

1) The OPR/STB and the BAND buttons are used for manual (local) control.

Please, see [Figure 3-2 Basic screen without ACOM 04AT antenna tuner assigned](#), Pos. (1)).

- The left-most button **OPR/STB** switches over the amplifier between OPERATE and STANDBY modes;

- The next two buttons - **BAND** up \triangle and down ∇ arrows change the frequency bands in ascending or descending order.



When ACOM 04AT tuner is assigned, **BAND** buttons are called **SEGMENT** and change the tuner frequency segments (see Section [4.3 Operation with an External Antenna Tuner](#)).

- 2) The right-most button **MENU** provides access to the amplifier's settings and service functions.

Please, see [Figure 3-2 Basic screen without ACOM 04AT antenna tuner assigned](#), Pos. (2).

- In each menu the left-most button is always **HELP** and the right-most - always **EXIT**;
- The **HELP** button provides information about the active screen.

For more details on the control system and use of the menus see Section [5 MENUS - SETTINGS AND OPTIONS](#).

3.6. Test Transmission

To make sure that you have installed the amplifier correctly, make a test transmission as described below. Repeat these tests for each new band and antenna, as well as after installing a new or repaired antenna, antenna switch, tuner, and / or the connecting cables.

- a) Check of RF bypass path of a non-driven amplifier

For this check the amplifier must be completely installed and connected according to Section [2 INSTALLATION](#), but not powered by the mains, i.e., the mains rocker switch on the rear panel must be turned off. In any case the LED above the **POWER** button on the front panel must be dark for this test.

First, check if the transceiver's reception is normal. If you observe a significant worsening of reception, first check for a problem in the coaxial connections to the amplifier (see Section [2.4.d\) RF INPUT socket](#) and [2.4.e\) RF OUTPUT socket](#)). Be sure to connect to the amplifier output an antenna having good SWR in the band being tested.

Provided the reception is normal, prepare the transceiver as follows:

- Select a continuous carrier mode (CW, RTTY, FM);
- Switch the microphone off (decrease the mic gain), disable FSK;
- Reduce the output power control to a minimum;
- Select a suitable indication so that you can watch the RF power and SWR at the transceiver output;
- If the transceiver has a built-in antenna tuner - switch it off.

Now in RECEIVE mode select a frequency which is not occupied at the moment and press shortly the PTT or TX key while watching the output power and the SWR readings. If the power or SWR at the transceiver output are too high (over 5 W or SWR over 2) release the key and check for the reason as follows:

- Check again whether the power control is set at minimum;
- Check whether the frequency is within the operating range of the selected antenna;
- Check the good working order of the coaxial cables, connectors, and feed lines from the transceiver antenna jack through the amplifier, the antenna switch or external tuner (if there is one) to the BALUN transformer, and the antenna itself (see Section [2.4.e](#)) *RF OUTPUT socket*).

If the power and SWR are as expected, transmit again and while watching the power and the SWR readings, increase transceiver power gradually from minimum to maximum (but not more than 200 W, in order to not overload the RF by-pass circuit of the amplifier).

If SWR remains below 2 (preferably below 1.5) at the last test, decrease the power from the transceiver to minimum again and continue with the next check-up.

b) Check-up in STANDBY mode

Turn the amplifier on, as described in Sections [3.1 Low Energy STANDBY Mode of the Power Supply](#), [3.2 Front Panel](#), [3.3 Initial Turning On](#), and [3.4 Basic Screen](#) (see [Figure 3-2 Basic screen without ACOM 04AT antenna tuner assigned](#)).

Make sure that the amplifier is in STANDBY mode. Push the **OPR/STB** button if needed to change to STB.

Repeat receive and transmit tests the same way you just did with the amplifier turned off but in STANDBY mode now. During these tests note also whether the forward and reflected power bar graph and digital readout (see Sections [3.4.e](#)) *Forward power bargraph and digital readout* and [3.4.f](#)) *Reflected power bargraph and readout*), show respective RF power presence. If the reflected power exceeds the forward power, verify that the input and output coaxial cables to the amplifier are not interchanged (see Sections [2.4.d](#)) *RF INPUT socket* and [2.4.e](#)) *RF OUTPUT socket*).



The power indication accuracy is optimized around the 1000 W level and usually it is unreliable below 50 W.

c) Entering OPERATE mode

At OPERATE mode the transceiver receiving should not suffer. If it worsens and besides the indicator RX changes into TX although the transceiver is in receive mode, check the control cable connected to the **KEY-IN** input (see Section [2.4.b](#)) *KEY-IN socket*) for a short circuit. A wrong connection to the transceiver could cause the same problem.

d) Test transmission

If not readily set by CAT, switch the amplifier to the same band as the transceiver and antenna.

Set the transceiver to a continuous carrier mode and minimum power. In OPERATE mode choose a free frequency and push the PTT or CW key briefly, while watching the amplifier's behavior:

- RX mode must change to TX;
- The reflected power must read below 20 W;
- The forward power must read between 20 and 150 W with minimum drive power from the transceiver (between 1 and 5 W);

If the above test goes normally, push briefly the PTT once again, this time watching the transceiver's SWR reading (i.e., the input SWR of the amplifier) - this must be below 1.2.

If the SWR to the transceiver is higher than 1.2, check the coaxial cable between transceiver's output and amplifier's input socket (see Section **2.4.d) RF INPUT socket**).

e) Setting of drive level and typical operation

After successfully passing of the above tests push PTT or CW key for several seconds, watching the forward and reflected power. Increase the drive power until the forward power bar graph and digital readout reach 1000 W. Upon reaching 1000 W forward power check the following parameters (continuous carrier operation):

- The reflected power must not exceed ~110 W (for SWR 2) or better still to be below 40 W (for SWR 1.5);
- PA DC CURRENT must be between 32 and 36 A. It is normal that the current varies within these limits when changing operating frequency and antenna impedance;
- PA DC VOLTAGE must be within 48-52 V;
- The transceiver's SWR reading must be below 1.2.

Enter the MEASURE menu (see **Figure 5-2 Menu AMP MEASURE**) and check:

- The drive power from the transceiver must be between 30 and 50 W;
- PA BIAS, must be between 1.8 and 2.0 V (typically 1.9 V);
- PA TEMPERATURE, which must be between the ambient and 80 °C (176 °F), depending on the power level and the duration of transmission.

f) Elimination of electromagnetic compatibility (EMC) problems

If you use an amplifier for the first time in your shack, you may need to make some improvements in the setup. It is possible you might experience tingling from metallic objects due to the stronger radiated RF field. It could affect the operation of your station or systems outside, if they are too sensitive - typical examples are the microphone, CW keyer, computer keyboard or mouse, as well as TV receivers, Hi-Fi, intercom or telephone setups and others.

For instance, induction of RF currents into the microphone, CW keyer or computer keyboard, may lead to distortion in the peaks or relaxation oscillation in SSB mode, "sticking" or breaking off the dots or dashes from a Morse keyer, or garbling computer screen images. For the elimination of such problems, we recommend that you take the following general measures:

- Minimize the radiation from the feed lines by reducing the common mode currents in them, improve the balance of antennas and feedlines;
- In case you use asymmetric antennas (GP and similar) install as many radials as practical (use a well-developed counterpoise system);

- Add current chokes on the coaxial feeders;
- Place as far away as possible (also by height) the radiating elements of antennas from the premises, where the affected devices are located. In this sense, asymmetrical antennas without a separate feeder (Long Wire, Windom, and similar) may cause more interference because their radiating element begins immediately from the shack (part of it is the feeder itself);
- If the use of asymmetrical directly fed "wire" antennas is inevitable, use mainly half wave or half wave multiple lengths - they have a high input impedance, operate respectively with a small current at the feed point, and in the grounding of the shack. Thus, you can reduce the strength of the disturbing RF fields more than 10 times (at the same radiated power) compared to the case with quarter-wave and multiple to quarter-wave antennas of this class - you should avoid them because they have a low input impedance and operate with a large RF current in the grounding system and in the power supply network respectively, i.e., they create stronger disturbances (RFI);
- Improve the RF grounding system: use the shortest and widest possible metal strips for the connections to ground and between the different gear in the shack. Connect one or more counterpoises (sized for the problematic band) to the feeder shield at the point, where it enters the building, and the same point - with the possibly shortest and widest connections - to the grounding system: this is a very efficient measure, in particular if the shack is located on a high floor above ground;
- To reduce the RF impedance of the grounding connections sheet metal stripes instead of flexible braids are preferred;
- Thread ferrite beads or snap-in ferrites with medium permeability (800-4000) over the power cord, the feeder and the signal cables leading to the affected devices (TV, etc.); besides the size, consider the frequency range in which the offered ferrites are effective - normally they are optimized for suppression of interferences on HF (with larger permeability), with medium permeability for HF-VHF or with low permeability - only the VHF range. The latter are ineffective for HF;
- Whenever possible use shielded cables and ground their shields at both ends;
- The addition of even quite simple low pass L/C or R/C filters directly to the disturbed inputs or outputs of the devices is very effective, provided it is practically applicable.

Last but not least, bear in mind that the benefit of the above measures is two-fold.

Firstly - they reduce the interferences from your transmissions to the ambient environment and secondly - they reduce the background noise floor for your reception.

Practically, with no great efforts, implementing the above measures, you can reduce the receive background noise floor with one or more S-units across the different bands. This will allow you not to miss weaker stations, which will hear you because of your increased transmission power.

And third, but very important: the EMI environment at your station will become safer for you and those close to you.

4. OPERATION

4.1. Change of Modes RX/TX and OPERATE/STANDBY; AUTO OPERATE User Setting

a) STANDBY mode

In STANDBY mode, as well as when the amplifier is not powered, receiving and transmitting (no more than 200 W) with the transceiver is done via RF bypass between **RF INPUT** and **RF OUTPUT** of the amplifier. In STANDBY, the transceiver's RF power is not amplified, the control **KEY-IN** input does not affect the operation, and the **KEY-OUT** output (see Section [2.4.c\) KEY-OUT socket](#)) follows the **KEY-IN** input unconditionally.

b) OPERATE mode

In OPERATE mode the receive-transmit (RX/TX) direction is controlled by the **KEY-IN** input:

- At open **KEY-IN** (OPERATE/RX mode), the transceiver receives the signals from the antenna through the same RF by-pass path between **RF INPUT** and **RF OUTPUT** as with amplifier turned off or in STANDBY mode;
- At grounded **KEY-IN** ((OPERATE/TX mode) the RF drive is amplified and fed to the antenna through the **RF OUTPUT** connector.



In order to provide time for the relays to switch safely from receive to transmit, the transceiver should provide a dead time, i.e., must "notify" the amplifier in due time by grounding the control **KEY-IN** input not later than 10 ms before feeding drive power toward the amplifier RF input. Otherwise, the protection system will read "HOT SWITCHING ATTEMPT" and will trip off.

In OPERATE mode the **KEY-OUT** output (see Section [2.4.c\) KEY-OUT socket](#)) follows the **KEY-IN** input only after all conditions for safe transmission have been found good by the amplifier control unit. When used, the **KEY-OUT** output duly disables transmission while the amplifier is not ready.

The two modes OPERATE and STANDBY may be changed:

- Manually (locally) - by pressing the OPR/STB button alternatively (see [Figure 3-2 Basic screen without ACOM 04AT antenna tuner assigned](#), Pos. (1));
- Automatically at a SOFT FAULT protection trip - when the AUTO OPERATE user setting is activated (see Section [4.1.c\) AUTO OPERATE user settings](#)).



Access to the OPERATE mode can be locked in the AMP SERVICE menu, the OPERATE ACCESS user setting (see Section [5.4 Menu USER PREFERENCES](#) and [5.4.e\) OPERATE ACCESS](#)).

c) AUTO OPERATE user settings

AUTO OPERATE user setting can be turned on/off by the operator in the USER PREFERENCES menu (see Section [5.4 Menu USER PREFERENCES](#) and [Figure 5-5 Menu USER PREFERENCES](#)) or by a remote control command.

When the AUTO OPERATE user setting is OFF, the two modes OPERATE and STANDBY can be changed alternatively by the **OPR/STB** button or by a remote control command. At a SOFT FAULT protection trip, the amplifier will revert to STANDBY and wait for the operator to return it to OPERATE by pressing the **OPR/STB** button.

When AUTO OPERATE is ON (see Section [5.4 Menu USER PREFERENCES](#)), the amplifier will start up in OPERATE mode as soon as you turn it on. At a SOFT FAULT protection trip, the amplifier will also revert to STANDBY, but will return automatically to OPERATE mode in about 4 seconds.

Even at AUTO OPERATE on, the operator can revert to and remain in a STANDBY mode manually by the **OPR/STB** button or by a remote command. The next **OPR/STB** button push or remote command will switch the amplifier to the OPERATE mode and restore the normal operation of the AUTO OPERATE user setting.

4.2. Band Change, Standard and Expanded Frequency Coverage

When connected to a transceiver with CAT, the amplifier will change frequency bands automatically, following the transceiver's operating frequency changes.

Without CAT connection, the bands can be changed either manually or automatically (by the built-in frequency counter).

The bands are changed manually by the up \triangle and down ∇ **BAND** buttons.

For an automatic band change via the built-in frequency counter, make a quite short pre-transmission (100 ms is enough - a CW dit, or a sound on SSB) and release the PTT for a moment before the main transmission.

If the new frequency is out of the amplifier's frequency range (see Section [8.1.a\) Standard Frequency Coverage](#)), the transmission request will be denied and the following fault message will appear on the screen:

"FREQUENCY OUT OF RANGE"

The amplifier specifications are guaranteed within the bands listed in Section [8.1.a\) Standard Frequency Coverage](#). Frequency coverage changes could be negotiated with ACOM company.

4.3. Operation with an External Antenna Tuner

At antenna SWR over 1.5, it is advisable you use an external tuner.

The ACOM 04AT Remote Automatic Antenna Tuner and Switch (see **Figure 4-1 ACOM 04AT Remote Automatic Antenna Tuner and Switch**) is designed to work with ACOM transistor (solid state) amplifier series, including the ACOM 1200S.



Figure 4-1 ACOM 04AT Remote Automatic Antenna Tuner and Switch

It tunes antennas having SWR up to 3 automatically, thus providing an optimum load for the amplifier within 5 seconds with improved harmonic suppression at that. The four-way antenna switch is controlled automatically or from the amplifier front panel.

The ACOM 04AT can be installed both in the shack and in a remote location (even out in the open, close to the antennas). It can be distanced up to 100 m (330 ft) from the amplifier, using a single coaxial cable.

The connection of ACOM 04AT will make accessible specific features on the amplifier display that provide a transparent operation by following frequency and antenna selection changes in less than 50 ms.

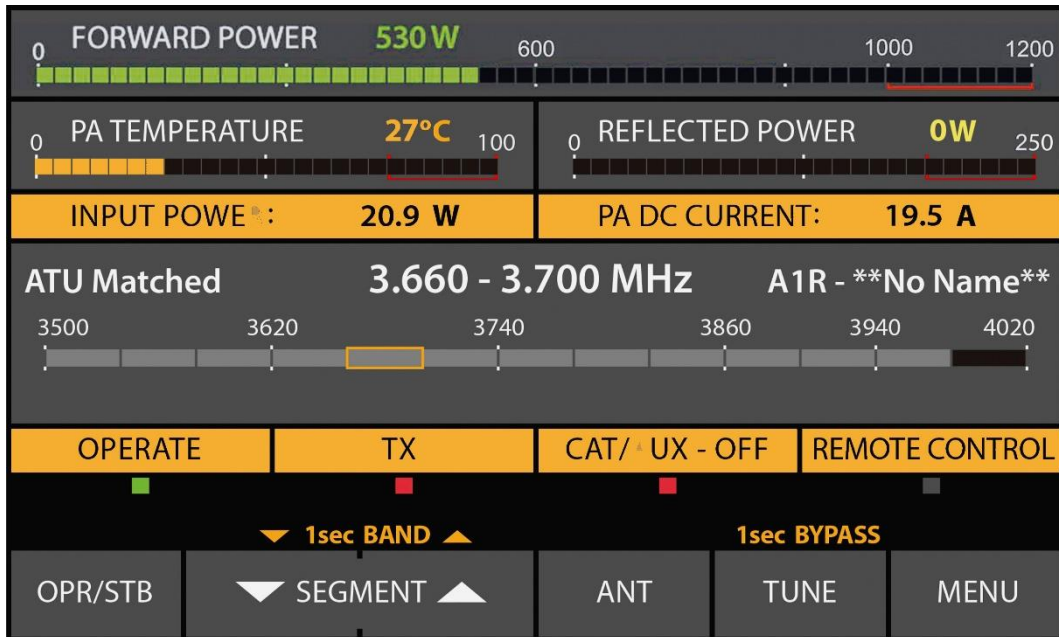

Figure 4-2 Amplifier screen with ACOM 04AT antenna tuner installed

The operation of ACOM 1200S with ACOM 04AT is described in detail in the ACOM 04AT User's Manual (available for download at www.acom-bg.com).

Pay particular attention to Sections **3.2 Indications, controls and menus**, and **4.2 Tuner Assignment and Unassignment** in the downloaded manual for details on ACOM 04AT control from amplifier front panel.



Use of other antenna tuners is not recommended.

4.4. Automatic Protection System

The ACOM 1200S control unit (see Section **7.4 Using the Fault Codes (signatures) for Diagnostics**) keeps track of most amplifier analogue and logic signals in all modes.

Those are the receive/transmit control signal, the output relay contact state and switching times, the RF drive frequency and drive power (the input power), the final transistors DC current and DC voltage on the drains as well as, the gates bias voltage and the heat sink temperature, the main power supply components temperature, the RF output forward and reflected power, and others. Some derivative parameters, as the power gain, the antenna SWR, the heat power dissipated by the final transistors and others, are watched too.

In the event a parameter limit is violated, the amplifier will assess the risk and will trigger one of the three levels of protection, as described in items (a) to (c) below. Every event is accompanied by a warning text on the screen (see *Figure 4-3 Appearance of an alarm message*). A sound alarm will be also produced, if set on in the USER PREFERENCES (see *Figure 5-5 Menu USER PREFERENCES*).

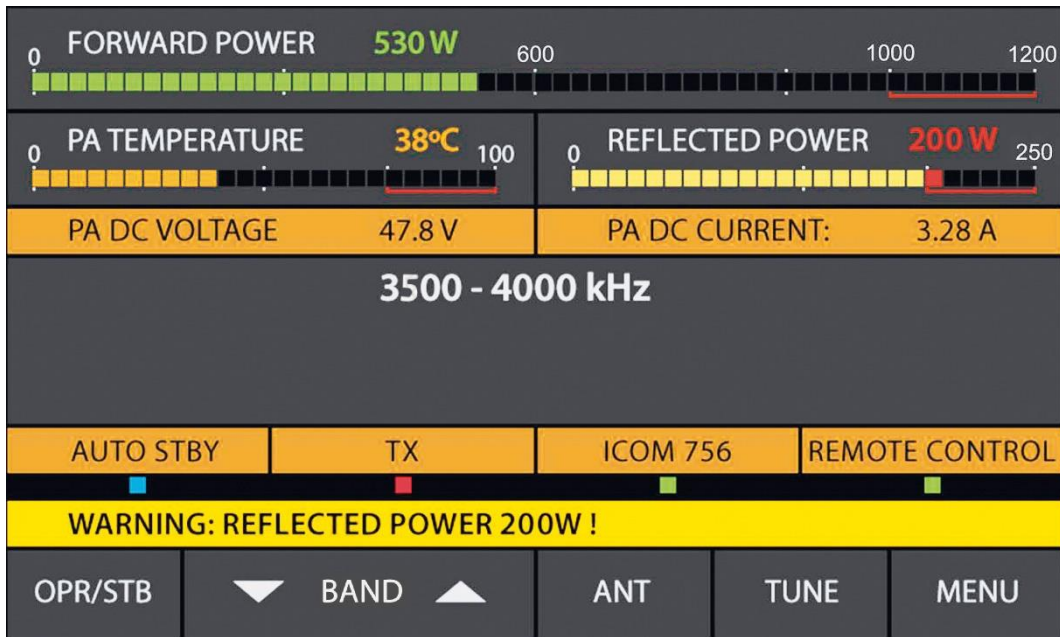

Figure 4-3 Appearance of an alarm message

a) First protection level - WARNING

The first (most forgiving) protection level is WARNING. When a value watched by the control unit approaches the protection threshold, the transmission is not interrupted, but a message appears - for example "Drive Power too High", "Drain Current too High", or another (see *Figure 4-3 Appearance of an alarm message*).

You can continue to transmit in these conditions, but you may take some measures, for example, to reduce a bit the drive power from the transceiver. The warnings remain on the screen for at least three seconds so that they can be read through and will disappear after the reason has dropped off.

b) Second protection level - SOFT FAULT

The second protection level is a SOFT FAULT - when a value exceeded the safe level, but does not put the amplifier in a danger of a failure.

At the second level (SOFT FAULT) the amplifier reverts to STANDBY mode for four seconds or permanently depending on whether the AUTO OPERATE user setting had been activated. A respective message is shown on the screen, for example "Excessive Reflected Power", "Excessive Drain Current", and others, accompanied by a sound alarm (unless the sound had not been muted (see Section [5.4 Menu USER PREFERENCES](#))).

Unlike those for a WARNING, the SOFT FAULT messages remain on the screen and persist until the operator pushes any button - in order to confirm that the message is read - or until the OPERATE mode is resumed automatically if the AUTO OPERATE user setting is active (see Section [5.4 Menu USER PREFERENCES](#)). A SOFT FAULT calls for fast and simple correcting actions by the operator, such as, for example, reducing the drive power, improving of load SWR through retuning the antenna tuner, antenna change, etc.

c) **Third protection level - HARD FAULT**

The third and most serious protection level is a HARD FAULT. The amplifier will be turned off automatically to avoid possible further damages.

When a HARD FAULT protection trips off, the data about the fault is stored in the memory and the front panel screen is blanked. There is also a sound alarm - a series of "F" sent in CW.

If the reason for tripping the protection is not obvious, you can try to turn on the amplifier. If the amplifier allows this after the fault, a fault message will appear with information about the reason for the latest automatic shutdown (for example, overheating of the power supply unit or of the PA stage).

After pushing any button, the fault message will disappear, and if there are no further problems (for example, the overheated unit has already cooled down), the amplifier operation will be restored. In the event a threshold is still violated, a new message will appear on the screen, or the protection will trip again immediately after the recovery attempt.



If the problem persists, contact your dealer (see Section [1.2 Owner Assistance](#)).

At each HARD FAULT shutdown, the amplifier stores diagnostic data, concerning the controls and values, the trip time, and others. Your dealer or his service may ask you to copy or take a picture on the data from the amplifier screen or download it by RS-232 interface and store it in a computer file (see Section [5.5 Menu FAULTS LOG](#) and [7.5 Firmware](#)).

5. MENUS - SETTINGS AND OPTIONS

By pushing the **MENU** button (the rightmost on *Figure 3-2 Basic screen without ACOM 04AT antenna tuner assigned*) the user invokes the MENU SELECTION screen (see *Figure 5-1 MENU SELECTION*). Each menu can be selected by the ▾ **ITEM** or **ITEM** △ buttons and **SELECT** button. These are described in Sections 5.1 through 5.6 below.

The items in each menu are selected and controlled by the same six buttons as in the basic screen, but they have new functions now.

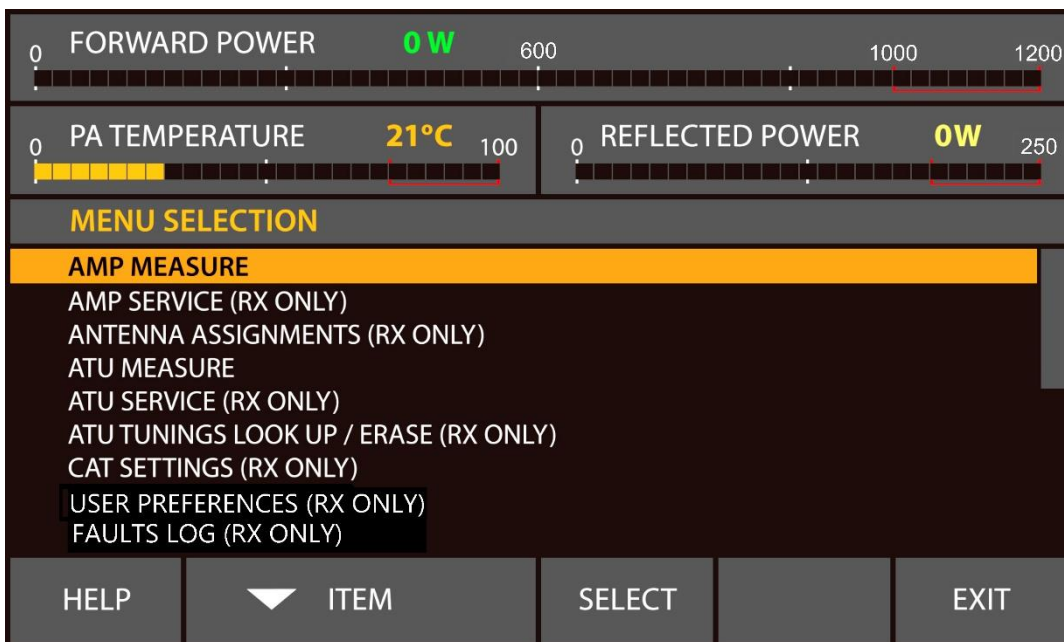

Figure 5-1 MENU SELECTION

5.1. Menu AMP MEASURE (Amplifier Measurements)

The menu AMP MEASURE (see *Figure 5-2 Menu AMP MEASURE*) is accessible from the MENU SELECTION screen (see *Figure 5-1 MENU SELECTION*) in all modes. Here you can constantly observe the values of eleven parameters.

Two identical lists appear on the left and the right halves of the screen, each one containing the same 11 values.

Any value can be selected in each screen half. Using buttons ∇ ITEM and ITEM \triangle (up and down arrows) select the desired values. The two currently selected values will appear also on the basic screen continuously (see *Figure 3-2 Basic screen without ACOM 04AT antenna tuner assigned*, Pos. (b)) - after leaving this menu (EXIT button).

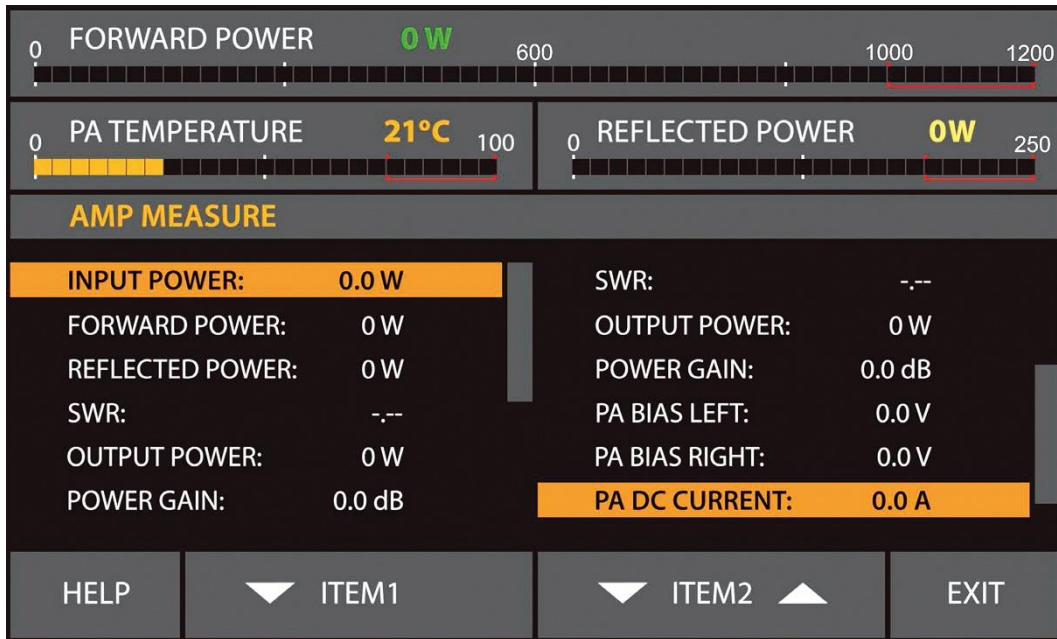

Figure 5-2 Menu AMP MEASURE

5.2. Menu AMP SERVICE (Amplifier Service Functions)

The amplifier service menu (see *Figure 5-3 Menu AMP SERVICE*) is accessible from the MENU SELECTION screen (see *Figure 5-1 MENU SELECTION*) at RX mode only.

NOTICE

The AMP SERVICE menu is used for checking and adjustment of the zero-signal (idle) drain current of the final transistors and for testing some functions and circuits of the amplifier when serviced. We recommend these procedures are carried out only by a trained service technician!

The necessary service function is selected with the buttons ∇ **ITEM** and **ITEM** \triangle (up and down arrows). With the \triangleleft **SELECT** and **SELECT** \triangleright buttons (left or right arrows) the selected function is turned ON or OFF.

The inactive functions are greyed out and the active are red. When leaving a function submenu, it is turned off and deactivated automatically. At pressing the **EXIT** button all service functions are turned off, and the MENU SELECTION screen comes back (see *Figure 5-1 MENU SELECTION*). At consecutive pushing of the **EXIT** button, the basic screen returns (see *Figure 3-2 Basic screen without ACOM 04AT antenna tuner assigned*).

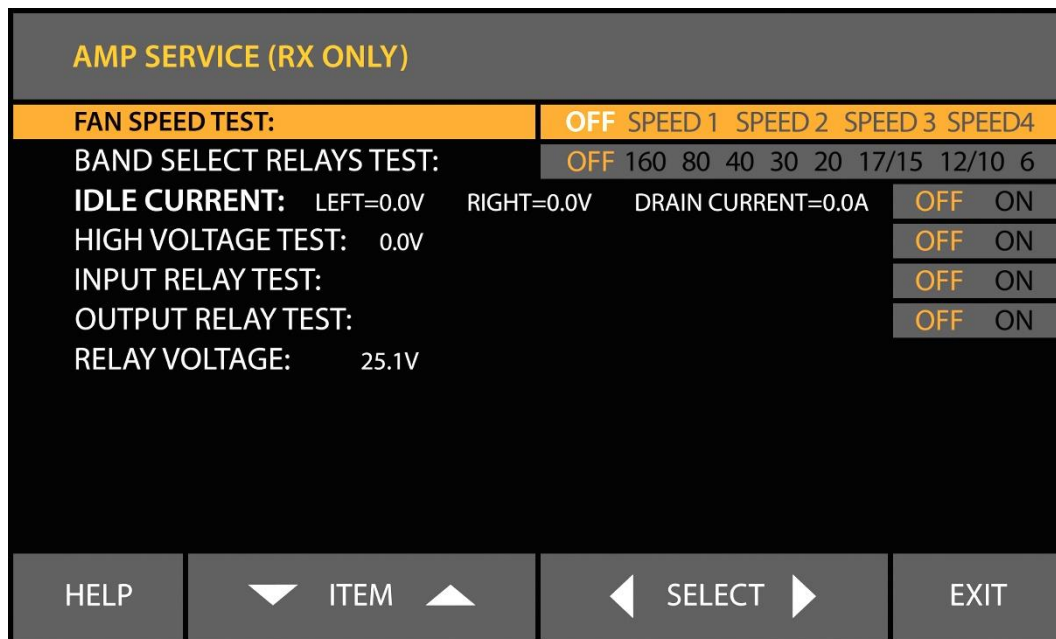

Figure 5-3 Menu AMP SERVICE

5.3. Menu CAT/AUX SETTINGS (Selection of CAT/AUX Interface)

After a CAT cable is connected between the transceiver and amplifier, the correct settings for the transceiver have to be set via this menu. If there is no CAT connection, OFF has to be selected as Interface type.

The CAT settings are accessible only in RX mode (see *Figure 5-1 MENU SELECTION* and *Figure 5-4 Menu CAT/AUX SETTINGS*). An item is selected by the **ITEM** ∇ and **ITEM** Δ buttons (up and down arrows). The value is set with the **SELECT** \triangleleft and **SELECT** \triangleright buttons (left or right arrows). Your selection appears in square brackets [x] on the screen.

If the amplifier **CAT** port is connected to the transceiver via either BCD Band Data or Band VOLTAGE output, select the respective interface type on top row and push **EXIT** button. The other items and values will be ignored with such a selection.

If the CAT cable is plugged into the transceiver's serial port, select the interface and command set according to *Table 5-1 Transceiver interface type and command set selection*. The baud rate has to be set to the same value as the transceiver's. The byte spacing and polling time may be left unchanged.

Last select the interface type (RS-232 or TTL) according to the *Table 5-1 Transceiver interface type and command set selection* and used connection, then push **EXIT** button to return to MENU SELECTION.

CAT/AUX SETTINGS (RX ONLY)						
INTERFACE:	[OFF]	RS232	TTL	BCD	VOLTAGE	
COMMAND SET:	1	2	3	4	[5]	
BAUD RATE, bps:	1200	4800	[9600]	19200	38400	57600
BYTE SPACING, us:	[0]	50	100	200	500	1000 1500
POLLING TIME, ms:	200	300	[500]	800	1200	1800 OFF
HELP	∇ ITEM	\triangleleft SELECT \triangleright		EXIT		

Figure 5-4 Menu CAT/AUX SETTINGS

Transceiver	Interface	Command set
ELECRAFT	RS-232	5
ICOM (Connection to the REMOTE jack)	TTL	1
ICOM (Connection to the RS-232 port or CT17)	RS-232	1
KENWOOD TS-2000, 480, 590, 890, 990 and similar	RS-232	5
YAESU FT-101, 450, 950, 991, 1200, 2000, 3000, 5000, 9000 and similar	RS-232	2
YAESU FT-1000MP	RS-232	4
YAESU FT-817, 857, 897	TTL	3

Table 5-1 Transceiver interface type and command set selection

Finish by moving the pointer out of the editable fields by means of the ◀ **SELECT** (left arrow) button.

e) **OPERATE ACCESS**

When locked, the amplifier remains in STANDBY and cannot be switched to OPERATE unless unlocked in the same menu. Passwords are not used - this is only a simple protection against possible child actions, or involuntary switching to OPERATE mode. While locked, an attempt for entering OPERATE mode will result in a message:

"OPERATE MODE IS LOCKED"

The other preference items are self-explaining.

5.5. Menu FAULTS LOG

This function reads on the screen the information stored in the memory about the last 28 HARD FAULT protection trips (see *Figure 5-6 Menu FAULTS LOG*). By pushing the **FILE** button, the information may be also downloaded in a plain-text format file through the RS-232 port and a computer using a standard terminal emulating program (TTY). The RS-232 protocol settings are: 9600, 8, N, 1,

Please, see Section *7.4 Using the Fault Codes (signatures) for Diagnostics*.

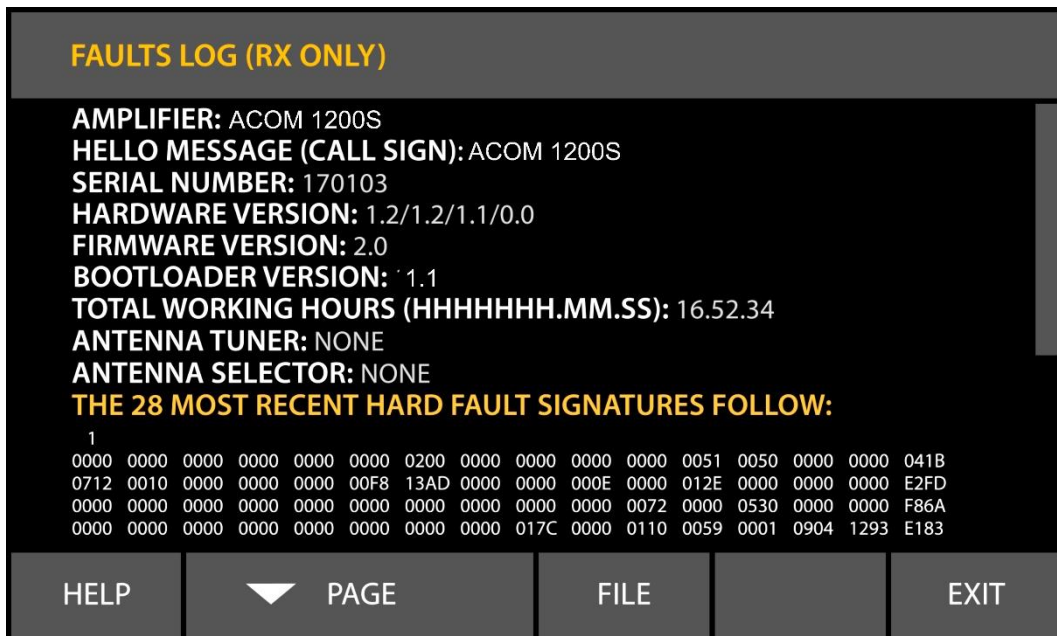

Figure 5-6 Menu FAULTS LOG

5.6. Menu RESTORE DEFAULT SETTINGS

Four different factory-reset levels are available (see *Figure 5-7 Menu RESTORE DEFAULT SETTINGS*).

In order to confirm the selected action, the operator must push the **▽ ACTION** (down arrow) button once more (as YES confirmation). After restoring the default settings, the control will return to the MENU SELECTION screen (see *Figure 5-1 MENU SELECTION*). If the **ACTION △** (up arrow) button is pressed, the NO is selected again, and the control will not leave the current position. At pressing the **EXIT** button in this position, the control leaves this menu without changing anything and returns in the previous window (the MENU SELECTION screen).

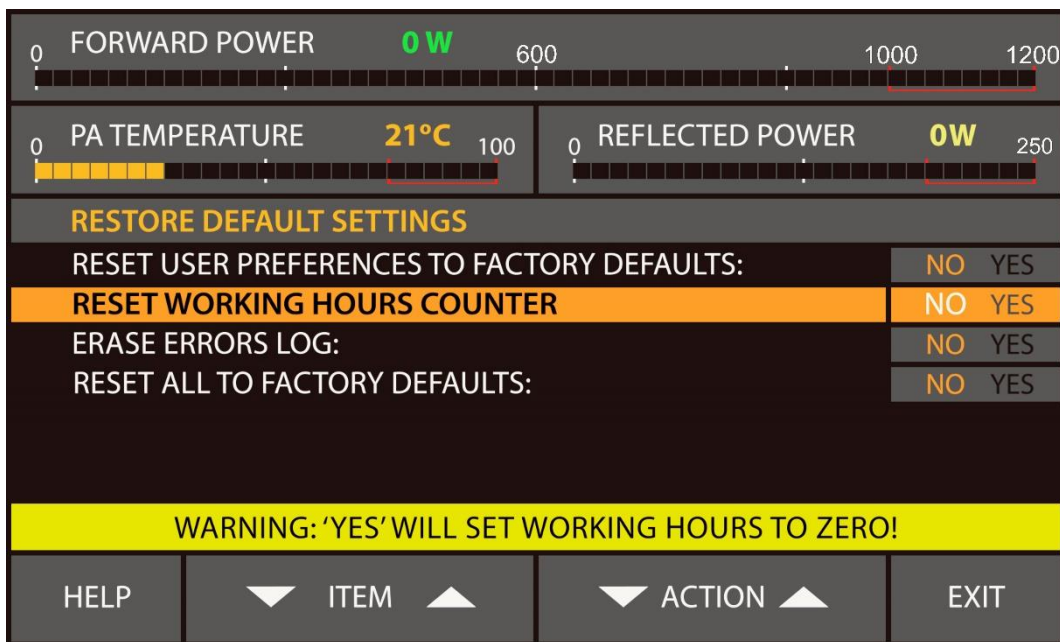

Figure 5-7 Menu RESTORE DEFAULT SETTINGS

6. REMOTE CONTROL

Remote control of ACOM 1200S is provided by either ACOM eBox Ethernet Remote Control device or RS-232 port.

6.1. Remote Control via ACOM eBox

Remote control of ACOM 1200S via Internet is provided by the ACOM eBox Ethernet Remote Control device. The operation of ACOM 1200S with ACOM eBox is described in the ACOM eBox User's Manual (available for download at www.acom-bg.com).



Figure 6-1 ACOM eBox Ethernet Remote Control device



Use of other remote control devices is not recommended.

6.2. Remote Control via RS-232 interface

The ACOM 1200S may be controlled remotely by the RS-232 port. For cable connection, please see Section [2.5.b\) RS-232 interface connector](#) and [Table 2-2 Signals and pin out of the RS-232 connector](#).



For ACOM 1200S RS-232 interface protocol, please, contact your dealer (see Section [1.2 Owner Assistance](#)).

7. MAINTENANCE

DANGER

Both the mains voltage and the high DC voltage up to 500 V inside the ACOM 1200S amplifier are LETHAL!

For your safety, pull the amplifier power plug out of the mains wall outlet and WAIT AT LEAST 3 minutes EACH TIME BEFORE you remove the cover of the amplifier.

7.1. Periodic Maintenance

a) Periodic checks

Periodically (but at least once per year) check all connections, contact cleanliness and the tightening of all connectors, in particular the coaxial ones.

Check the integrity of the cables, in particular when they are laid on the floor. Check also if the cables are secured well in the area where they come out of the connector body.

Pay particular attention to the mains plug and the wall outlet (see Sections [2.4.g\) The IEC 320 Power inlet](#) and [2.4.h\) Preparation of wall outlet](#). If you have any doubts consult with a qualified electrician.

Periodically check the SWR of the antennas and if this changes over time. Problems could occur more often in poor weather conditions - rain, snow, strong wind etc.

b) Air filters

ACOM 1200S has two air filters that are accessible from the bottom (see [Figure 7-1 Bottom view - Air Filters](#)).

Periodically (more often in a dusty environment, but at least once per year) clean the air filters **without opening the amplifier**.

CAUTION

The air filters may be too dusty - be careful how you clean them so that you DO NOT INHALE (BREATHE IN) neither spill the dust over! Wrap them, for instance, in a wet cloth before cleaning!

- PA air filter

Please, see [Figure 7-1 Bottom view - Air Filters](#), Pos. (1).

- Use a Philips-1 screwdriver to unscrew the 4 mounting screws ([Figure 7-1 Bottom view - Air Filters](#), Pos. (3));
- Remove the square filter cover ([Figure 7-1 Bottom view - Air Filters](#), Pos. (5));
- Take out gently the foam-like plastic filter.

- PS air filter

Please, see **Figure 7-1 Bottom view - Air Filters**, Pos. (2).

- To remove the filter unscrew the 2 mounting screws (**Figure 7-1 Bottom view - Air Filters**, Pos. (4)), while holding the bottom;
- Using a small flat screwdriver or tweezers gently lift the filter tray away from the amplifier body.

Carefully clean the filters and covers from dust, wash them with tap water and leave them to dry up before you mount them back.

Finally, mount the air filters in place in reverse order described above and fasten the screws tightly.

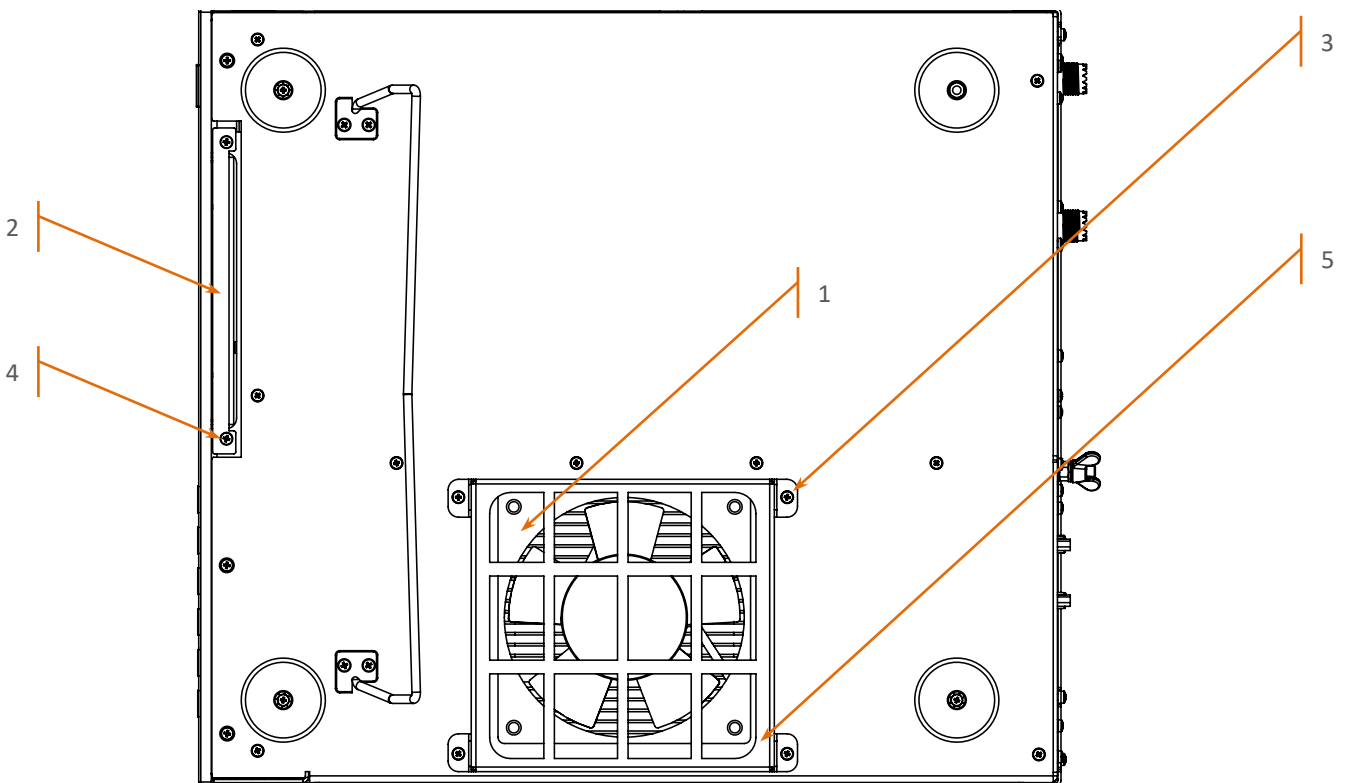

Figure 7-1 Bottom view - Air Filters

⚠ CAUTION

The air filter may be too dusty - be careful how you clean it so that you **DO NOT INHALE (BREATHE IN)** neither spill the dust over! Wrap it, for instance, in a wet cloth before cleaning!

7.2. Cleaning

⚠ CAUTION

Do not use any solvents for cleaning. They may be dangerous to you and damage amplifier surfaces, paint and plastic components.

Do not open the amplifier. Cleaning of the amplifier outer surfaces can be done with a piece of soft cotton cloth lightly moistened with clean water.

Also, clean (as much as possible from the outside, without opening the amplifier) all ventilation apertures on the cover and the chassis, including the ones on the bottom.

⚠ DANGER

Never push or put anything into holes in the case - this will cause electric shock.

7.3. Fuse Replacement

⚠ DANGER

If replacement of fuses is necessary, first pull out the amplifier mains plug from the mains outlet and wait for at least 3 minutes!

NOTICE

For replacement, only use standard fuses from the types recommended below.

The two Primary Mains Fuses of the amplifier are located on the rear panel (see *Figure 2-2 Rear panel - Connections*, Pos. (f)). They are fuses of the "F" type (fast-acting / quick-acting / quick blow), European size 5x20 mm, ceramic (or glass) body cartridge.

The fuses must be rated for 10 A / 250 V.

Suitable 10 A fuse is Littelfuse, PN: 0217010.H (glass body cartridge);

This fuse can be ordered from:

- DigiKey (www.digikey.com), PN: 0217010.MXBP-ND;
- Farnell (www.farnell.com), PN: 1191761;
- Mouser (www.mouser.com), PN: 576-0217010.



If, after Primary Mains Fuses replacement, the device does not operate normally, we recommend repair, performed only by a trained service technician.

Contact your ACOM dealer for assistance (see Section [1.2 Owner Assistance](#)).

Besides the primary fuses, there are internal fuses inside the amplifier.

WARNING

Do not replace internal fuses located inside the amplifier.

Blown internal fuses can be a symptom of a more serious problem, which should be resolved beforehand. A fault of this type will not occur under normal operating circumstances.

Replacing internal fuses is a complex and potentially dangerous operation. For this reason, we recommend this work be carried out only by a trained service technician.

Contact your ACOM dealer for assistance (see Section [1.2 Owner Assistance](#)).



Unauthorized replacement of inside fuses infringes the warranty conditions!



Besides several specific national standards, the principal fuses standard applied worldwide is IEC 60127.

7.4. Using the Fault Codes (signatures) for Diagnostics

The data of the last 28 HARD FAULT protection trips is stored in the amplifier memory (see Section **5.5 Menu FAULTS LOG**).

The data can be downloaded from ACOM 1200S memory through the RS-232 port and stored in a computer file even if the amplifier cannot be turned on after a serious fault - only external power has to be fed to the Control unit in either of the following ways:

- 8 to 15 V DC voltage applied to the "DEBUG mode" input (see **Table 2-1 Signals and pin out of the CAT/AUX connector**) of the CAT/AUX port. The power supply has to be capable to provide 0.4 A of current;
- If the Control board has already been taken out of the amplifier, it can be powered directly with +5 V (0.4 A) and the fault log downloaded via the RS-232 port.

In the FAULT LOG reading mode (see Section **5.5 Menu FAULTS LOG**), the Control board automatically transmits the data from the memory through the RS-232 interface (see Section **2.5.b) RS-232 interface connector**). Depending on the number of fault events stored in the memory, the transmission may take between 0.5 and 12 seconds. A pause of 6 seconds follows, then transmission starts again. The data can be read in a plain-text format with a computer, using a standard terminal emulating program (TTY).

You can send the recorded file to your dealer or to ACOM accordingly.

To decode the downloaded hexadecimal data you have to use the **ACOM Hard Faults Signatures Converter** (Excel file), distributed by ACOM free of charge. You can download it from www.acom-bg.com.

7.5. Firmware

7.5.1. Firmware Versions

The history of available ACOM 1200S CPU Module firmware versions is shown in **Table 7-1 ACOM 1200S firmware versions history**.

Version	Release Date	Notes
1.0	11.02.2017	Base firmware version;
1.1	05.10.2017	Serial communication to PC improved; Elecraft K3 CAT issues fixed; ATU full tune procedure improved;
1.3	11.02.2018	Serial interface band and mode selection fixed; Yaesu FT-991A CAT support added;
1.4	26.06.2018	ATU write off fixed;
2.1.2	12.06.2021	Hardware and software revised.

Table 7-1 ACOM 1200S firmware versions history

The new firmware is issued as a file, for example **ACOM_1200S_FW V1.4 - 26.06.2018.DAT**. You can download the available firmware from www.acom-bg.com free of charge.

7.5.2. Prequisites



Before you change the firmware version, check the new version compatibility with the revisions of the hardware and of the boot loader in your amplifier (see **Figure 5-6 Menu FAULTS LOG**). If you have any doubts about the versions, please, consult your dealer before you undertake any action.

When ACOM issues a new firmware version, the user can upload it in the amplifier after he checks the compatibility. When compatibility is confirmed a return to an earlier version is also possible.

7.5.3. Firmware Updates

For uploading a firmware to ACOM 1200S you have to use the **ACOM Terminal S** software, distributed by ACOM free of charge. You can download it from www.acom-bg.com.

To use the **ACOM Terminal S**, you have to install the software on PC equipped with RS-232 port. The **ACOM Terminal S** communicates with amplifier via RS-232 interface. For cable connection, please see Section **2.5.b) RS-232 interface connector** and **Table 2-2 Signals and pin out of the RS-232 connector**.

The **ACOM Terminal S** is available for MS Windows, Apple Mac, and Linux operation systems.

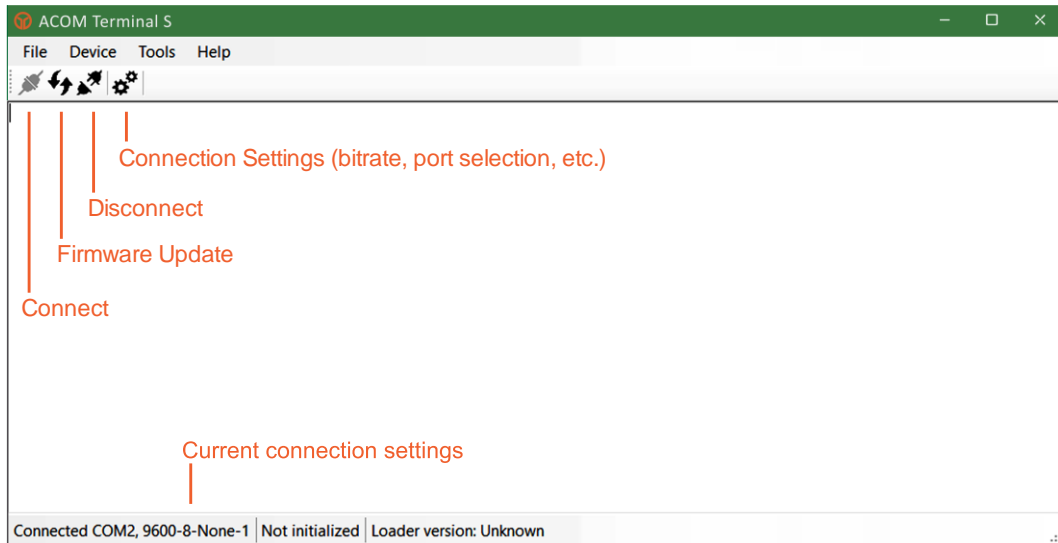

Figure 7-2 ACOM Terminal S screenshot



For detailed instructions how to upload a firmware, please, read **Help** information in **ACOM Terminal S** software.

We strongly recommend that you backup your current amplifier firmware before performing an update procedure!

8. SPECIFICATIONS

8.1. Parameters

a) Standard Frequency Coverage*

1.800 - 2.000 MHz	(160 m band)
3.500 - 4.000 MHz	(80 m band)
5.020 - 5.455 MHz	(60 m band)**
7.000 - 7.300 MHz	(40 m band)
10.100 - 10.150 MHz	(30 m band)
14.000 - 14.350 MHz	(20 m band)
18.068 - 18.168 MHz	(17 m band)
21.000 - 21.450 MHz	(15 m band)
24.890 - 24.990 MHz	(12 m band)
28.000 - 29.700 MHz	(10 m band)
50.000 - 54.000 MHz	(6 m band)**

b) Rated Output Power

- 1000 W \pm 0.5 dB, PEP or continuous carrier, without mode limitation;

NOTICE

You will have to reduce the output power to about 500 W in order to keep the mains current consumption below 10 A if the amplifier is operated at below 200 VAC mains supply voltage.

c) Intermodulation Distortions (IM3)

- Better than 31 dB below rated PEP;

d) Harmonic and Parasitic Emissions Output Suppression

- Better than 60 dB (65 dB typically);

e) Input and Output Impedances

- Nominal value: 50 Ohm unbalanced, UHF (SO-239) type connectors;
- Input circuit: Broadband, SWR below 1.2 (1.1 typically), 1.8-54 MHz continuous range without retuning or switching;
- RF bypass path SWR - below 1.1, 1.8-54 MHz;

* Extensions or changes of the frequency coverage are possible on request.

** Please, refer the applicable regional bandplans and laws for specific allocations and limitations.

- Acceptable SWR at the output load (the antenna): up to 3 with proportional power reduction and up to 1.5 for full output power;
- f) RF power gain
- 14 dB \pm 1 dB (typically 40 W for 1000 W output power);
- g) Mains Power Supply Voltage
- 100-240 VAC;
 - Below 200 VAC the output power is reduced to 500 W;
- h) Mains Power Consumption at Full Output Power
- Power factor of 0.95 or higher;
 - Up to 2100 VA at rated output from 200/240 VAC mains supply;
 - Up to 1100 VA at 500 W output from 100/120 VAC mains supply;
- i) Mains Power Consumption in Low Energy (Waiting) Mode
- Less than 1 VA;
- j) Receive / transmit control
- **KEY-IN** input - Phono RCA jack.
 - Voltage applied to the transceiver keying output - up to +12 V;
 - Closed-circuit current flow to the transceiver keying output - up to 6 mA;
 - **KEY-OUT** output - open-drain, Phono RCA jack.
 - Output resistance: not more than 120 Ohm;
 - Maximum allowable open-circuit voltage coming from transceiver connection: +50V;
 - Maximum allowable closed-circuit current flow by the transceiver: 20 mA;
 - Minimum dead time, necessary for safe amplifier switching over from receive to transmit: 10 ms between the transmit request on the **KEY-IN** input and the RF drive on the **RF INPUT** jack.
- k) Safety and Electromagnetic Compatibility
- Complies with CE safety and electromagnetic compatibility requirements, as well as with the US Federal Communications Commission (FCC) regulations;
- l) Size & Weight (operating, excluding connected cables and tilt foot bar)
- WxDxH: 372x418x162 mm, 16.0 kg (14.7x16.5x6.4 inches, 35.3 lbs);
- m) Operating Environments
- Temperature range: -10 to +40 degrees Celsius (14 °F to 104 °F);
 - Relative air humidity: up to 95% @ 35 degrees Celsius (95 °F);
 - Height: up to 3050 m (10000 ft) above sea level without output deterioration.

8.2. Functions

- a) Frequency control directly by CAT from the transceiver
- b) Remote control through ACOM eBox Ethernet Remote Control device or via RS-232 interface
- c) Remote POWER ON by DSR/DTR and CTS/RTS lines on the RS-232 port or by ACOM eBox Ethernet Remote Control device
- d) Remote POWER ON / TURN OFF by DC voltage impulse or continuous DC voltage on CAT/AUX port ON_RMT input.

8.3. Storage and Shipment

8.3.1. Storage Environment

The amplifier may be kept packed in a dry, ventilated and unheated location (with no chemically active substances such as acids or alkalis) within the following environment ranges:

- Temperature range: -40 to +70 degrees Celsius (-40 °F to 158 °F);
- Humidity: up to 75% @ +35 degrees Celsius (95 °F).

8.3.2. Shipping Size and Weight

- WxDxH: Approx. 550x540x360 mm, 19.0 kg (21.7x21.3x14.2 inches, 41.9 lbs.);

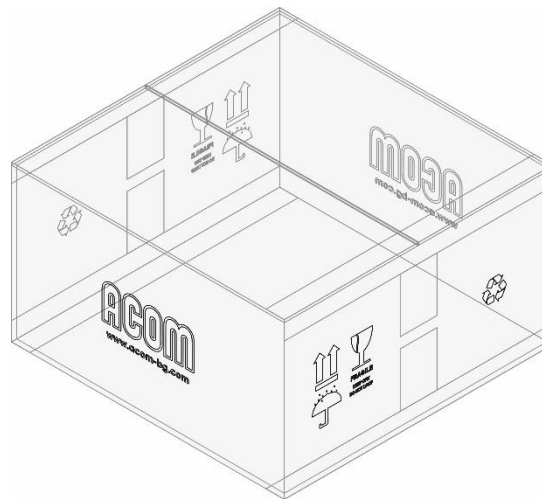

Figure 8-1 Packaging cardboard box

8.3.3. Transportation

All types of transportation may be used, including storage in an aircraft baggage compartment at up to 12000 meters (40000 ft) above sea level.

8.3.4. Returning to the Service Provider

NOTICE

Should it be necessary to ship the amplifier, use the original packing as described below.

Switch off the amplifier, pull the line (mains) plug out of the outlet, disconnect all cables from the rear panel of the amplifier (remove the ground connection the last), and then pack the amplifier in its original carton.

8.4. Information on Disposing and Recycling of Old Electrical and Electronic Equipment



The information in this section is applicable for countries that have adopted separate waste collection systems.

ACOM products cannot be disposed as household waste.

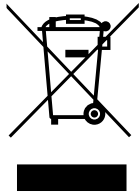

Waste electricals

This symbol (crossed-out wheeled bin) explains that you should not place the electrical item in the general waste.



Waste electricals

This symbol (three green arrows going in a triangle with electrical plug in the center) means that according to local laws and regulations this product should be sent for recycling.

Old electrical and electronic equipment and batteries should be recycled at a facility capable of handling these items and their waste byproducts.

Contact your local authority for details in locating a recycle facility nearest to you.

Proper recycling and waste disposal will help conserve resources whilst preventing detrimental effects on our health and the environment.



NOTES

A series of horizontal dotted lines for taking notes.

This manual is for electronic distribution mainly.
If you have it on paper and you no longer need it, please, recycle it!

The latest versions of our User's Manuals are available at
www.acom-bg.com

Dealer/Partner's address:

ACOM



📍 ACOM Ltd.

Bulgaria | Bozhurishte 2227
Sofia-Bozhurishte Economic Zone | 6 Valeri Petrov Str.
GPS coordinates: 42.748616° | 23.209801°

📧 support@acom-bg.com

ACOM and the ACOM logo are registered trademarks of ACOM Ltd. in many countries, including the EU and United States. | The used images are illustrative only. Subject to change without notice. | Printed in Bulgaria. All rights reserved. | Design and content by ACOM Ltd.

ACOM 1200S User's Manual | Fourth Edition, Revision 01 | August 2021.



www.acom-bg.com